

I. _____

1

2

3

4

5

6

7

8

9

10

11

12

13

14

15

16

17

18

II. _____

1)

2)

3)

4)

5)

6)

7)

8)

9)

10)

11)

III. _____

1)



危險

2)

3)

4)

5)

12

6)

7)

8)

9) V

10)

11)

12)

13)

1.		8
1.1		8
1.2		9
1.3		9
2.		9
2.1	/	9
2.2		10
2.3		10
2.4		11
2.5	/V	11
3.		14
3.1	/	14
3.2		14
3.3		15
3.4		16
4.		18
4.1	/	18
4.2		19
4.2.1		19
4.2.2		20
4.3		20

5.	/	22
5.1		22
5.2		24
5.3		26
5.4	/	31
5.5		34
5.6		34
5.7		34
5.8		37
5.9		38
5.10	/	40
5.11		44

1

1.1

Phoenix



危險

1.2

1

2

3

1.3

100 mm

30

90

2

2.1 /

2.2

2.3

		1000	1200
	HX	17800kg	18500kg
	HB	17500kg	18300kg
		1970kg	2070kg
		970kg	1220kg
1+ 2		5300kg	5400kg
1+		4700kg	4700kg
		1370kg	1410kg
		2900kg	2900kg
		3100kg	3500kg
		4200kg	4500kg

2.4

1/1000 mm

PEBRAS主机



2.5

/V

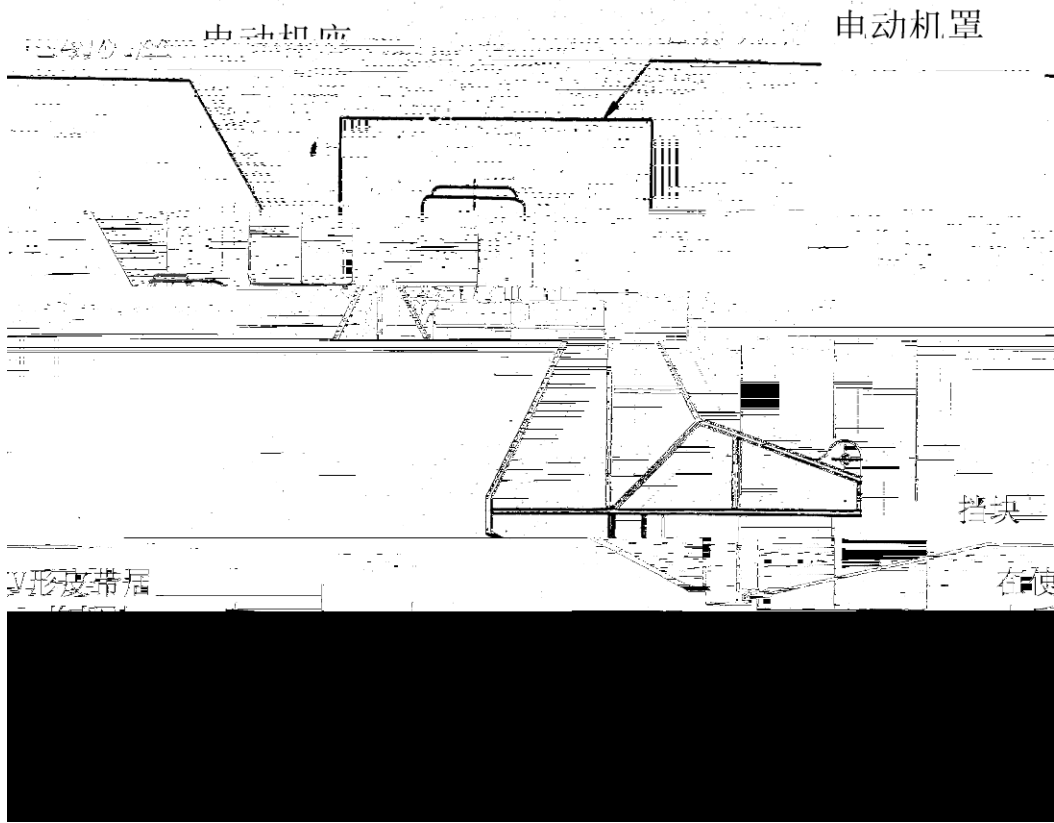

V

4/1000 mm

V

V

1 mm

0.0161 mm =

1

PEBRAS

	V		W	N	W N
1000	8V	300-420	227	197	153
1200		421-520	254	222	172
		521-630	273	237	184

1.

24

B3C10DCINZGGCOEEce

3

3.1 /

1 V

2 /

3 V

4

5

3.2

1

2

3

4

5

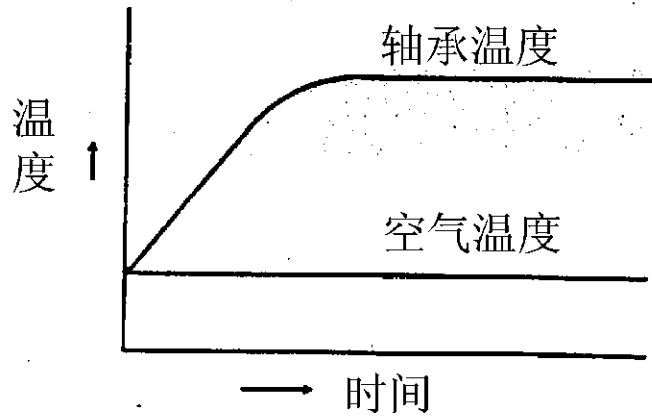

5

6

3.3

1

2

5 mm

5 mm

1m³

3

HX

HB

	mm		
	HX		HB
1000	25	35	45
1200			

4 1000 1200

70 /

HX

60 /

70 /

HB

45 /

50 /

60 /

5

2

6

3.4

(1)

V

N.L.G.I. Code No. 2

ASTM

25

.265~295

()

(2)

(1)

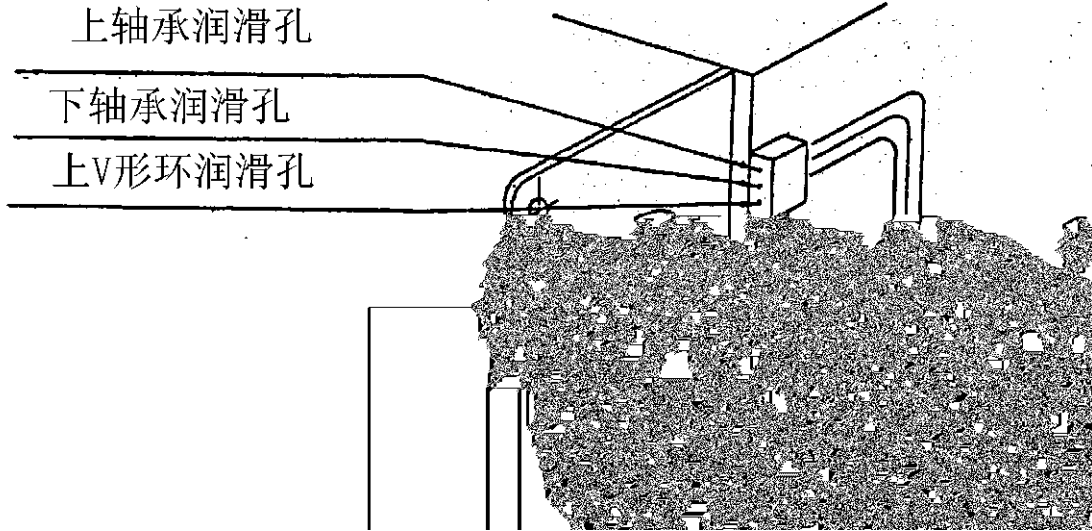

(3) KH 1100 8 (10)

V (10)

(KH 1100 2.6 lcc)

(4) V V V

V

()

()	V
IDEMITSU OIL	DAPHNI CORONEX GREASE EP NO.2
ESSO STANDARD OIL	LISTAN EP2
SHOWA SHELL OIL	ALVANIA EP GREASE-2
KYODO OIL	KYOSEKI RISONIX GREASE EP-2
NIPPON OIL	APINOX GREASE AP-2

4

4.1 /

1

2

3

4

5 5000

4.2

4.2.1

			/
			3mm 3mm

	/		

4.2.2

4.3

		/
	V	1. 2. V

5 /

5.1

	1000	1200
	4	4
	4	4

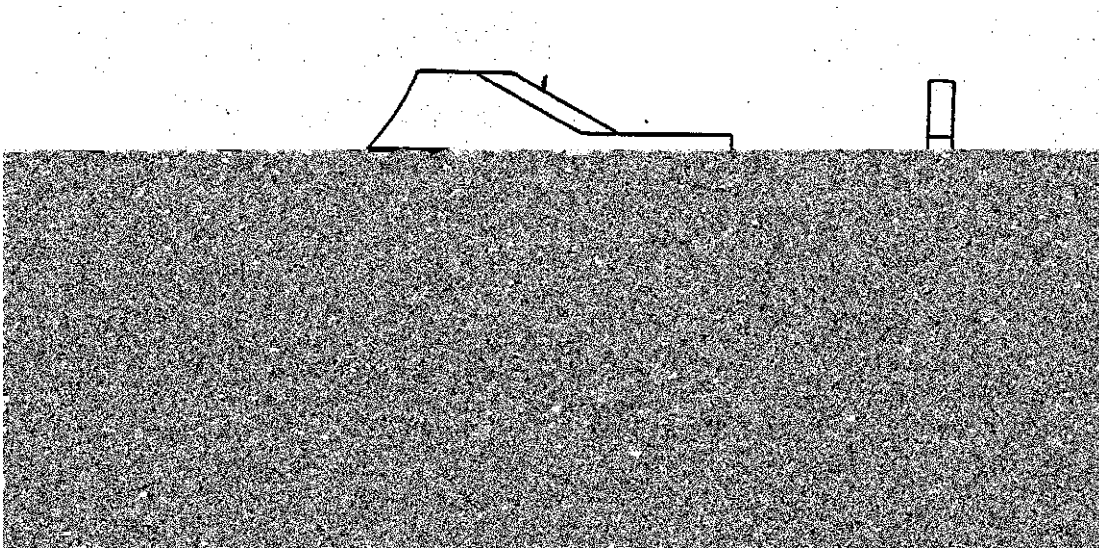

a b c

a

b

c

a

c

a

b

c

1

2

3

4

1.

2.

3.

1 3 m

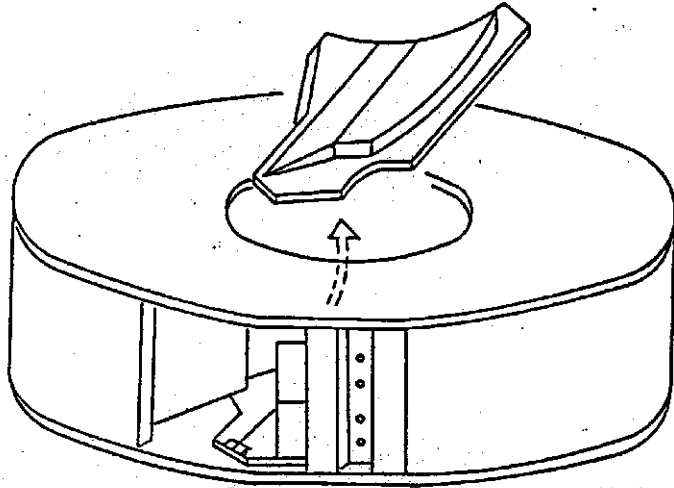

首先取下外刀架

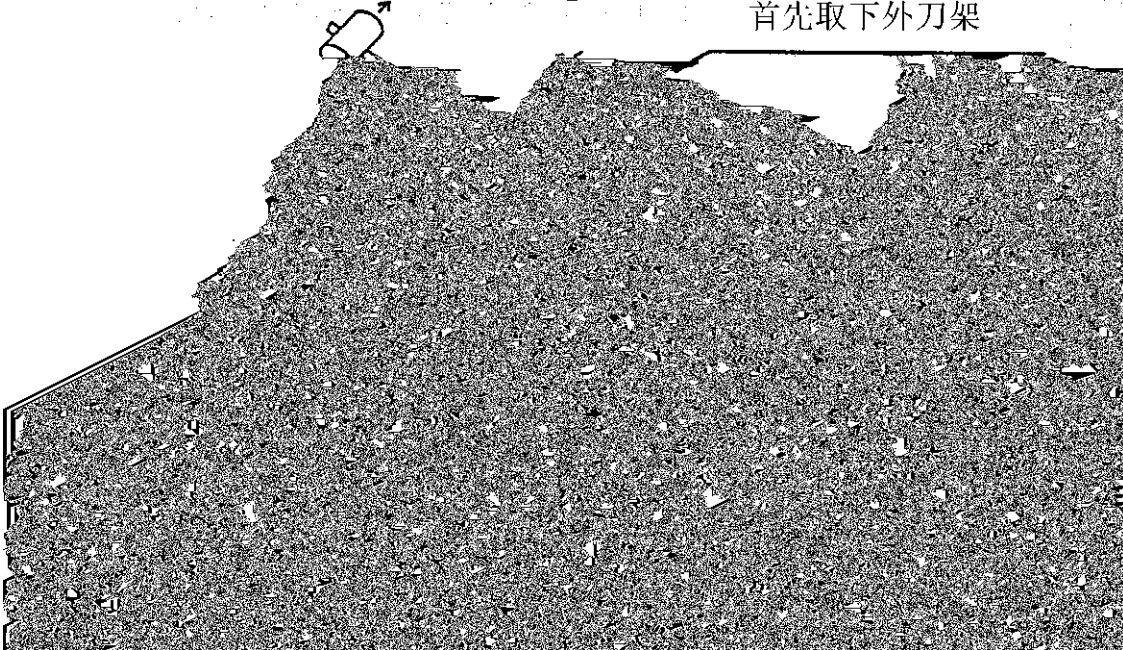

5.2

	1000	1200
	8	8

*1 HX

HB

*2

1000

1200

2

/

A

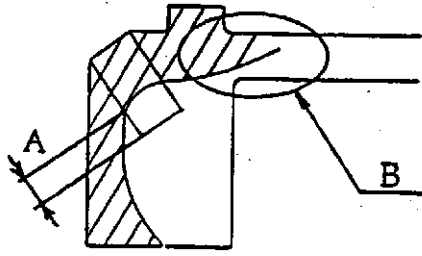

采用高圆周速度时

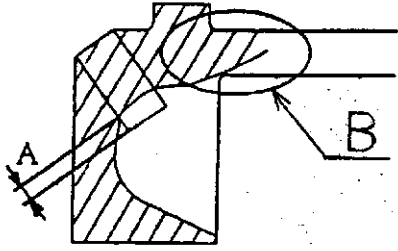

外刀架中心

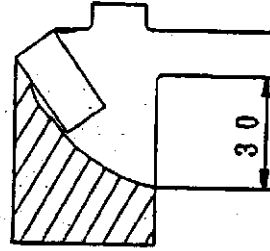

外刀架的上侧或者下侧

1.

A 5 mm

A 15 mm

A 15 mm

A

3

2

B

B

3.

B

1

2

5.3

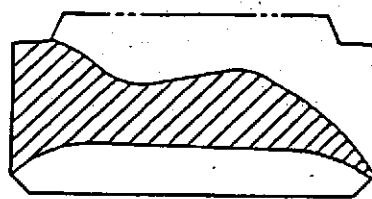
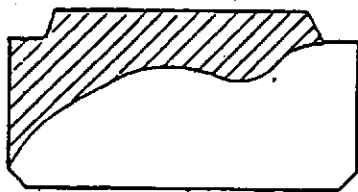
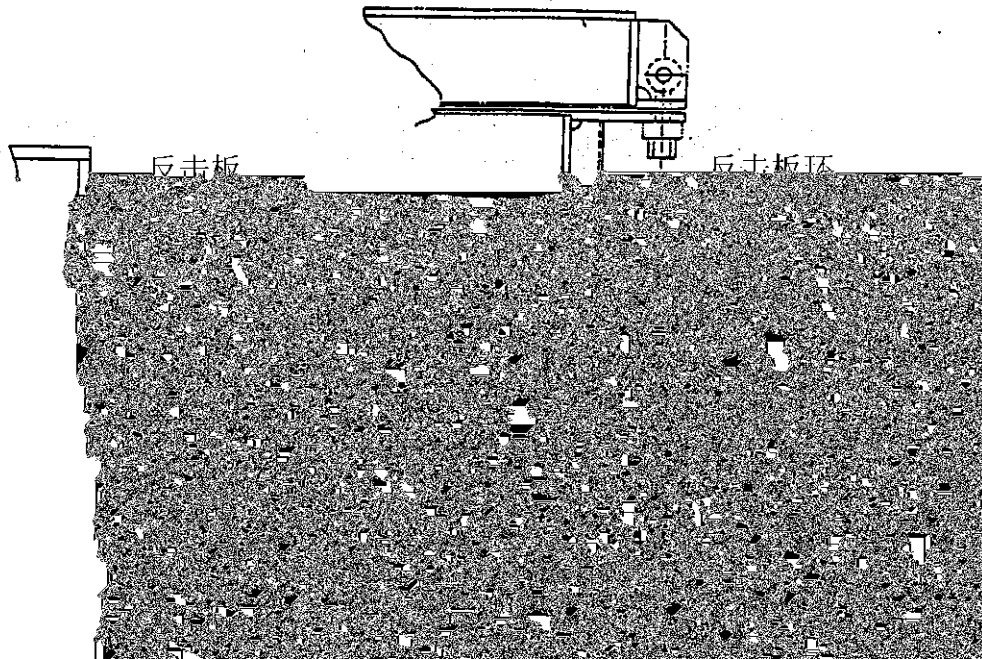

对最易磨损处进行判定 (见25页)

反击板向上/向下运动和倒置指南

反击板更换指南

1

2

3

1

4

5

6

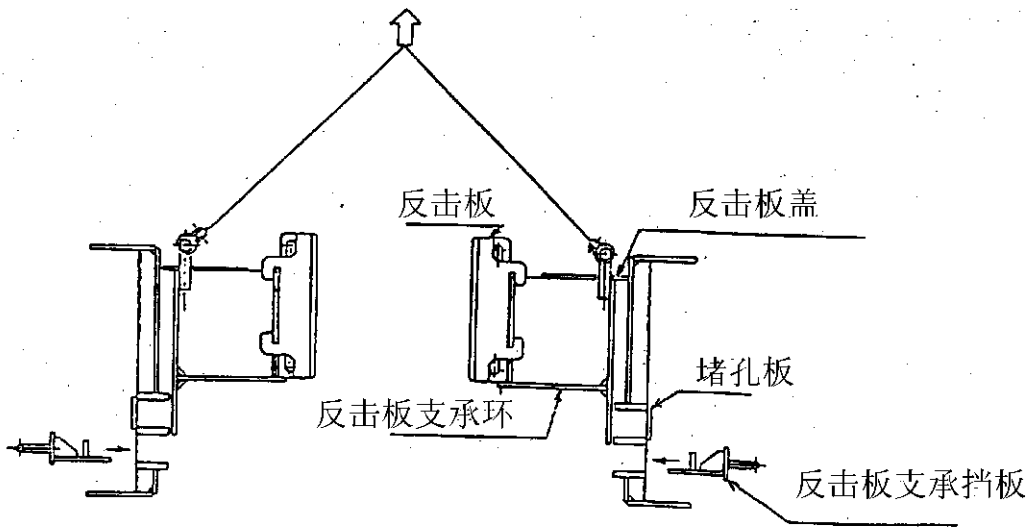

1.1000 1200

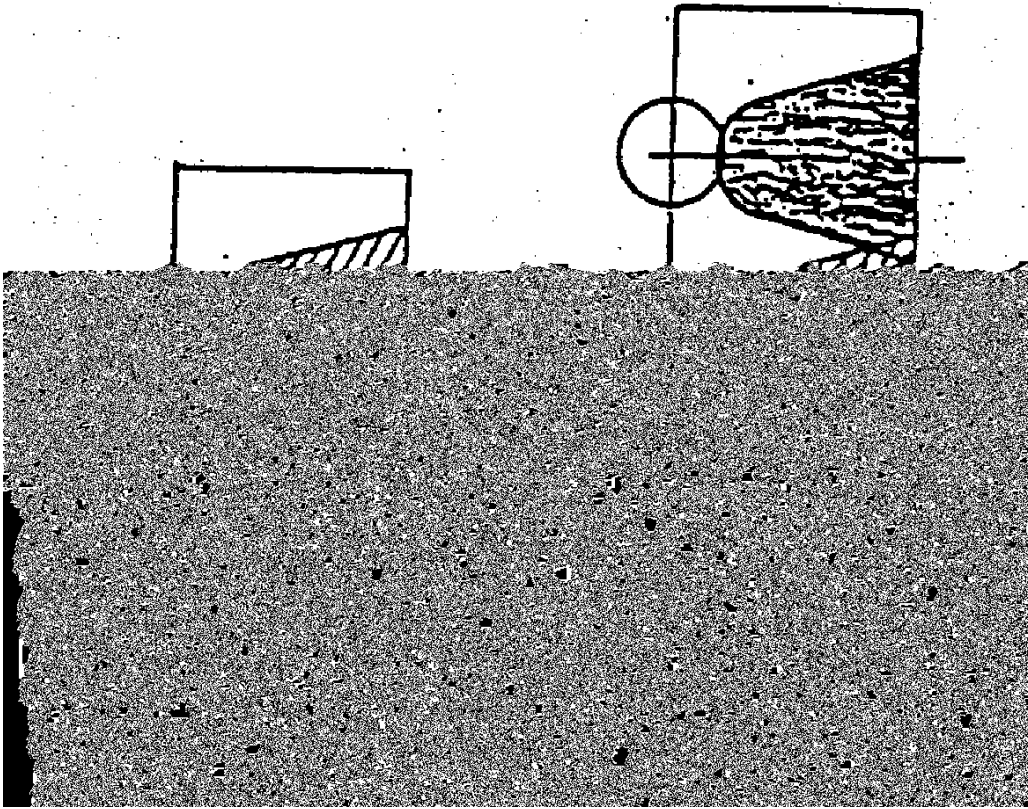

1000 1200

0

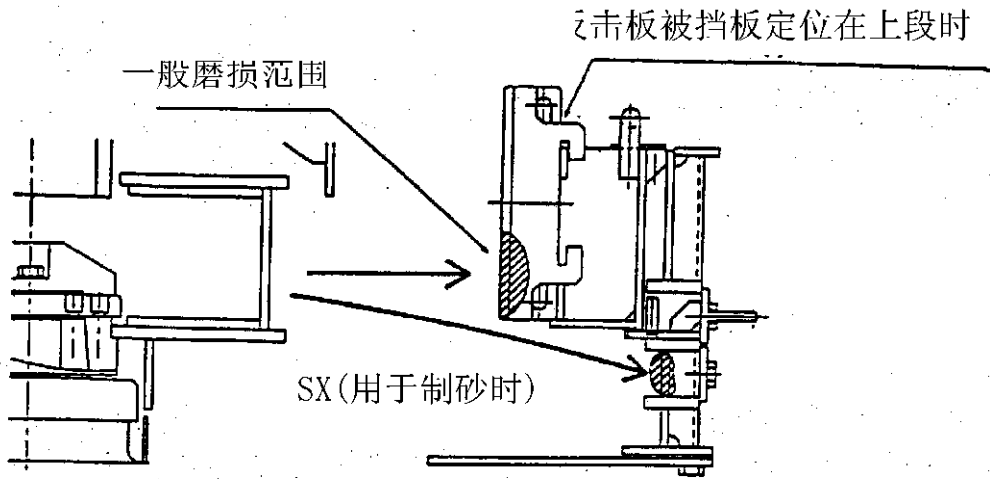

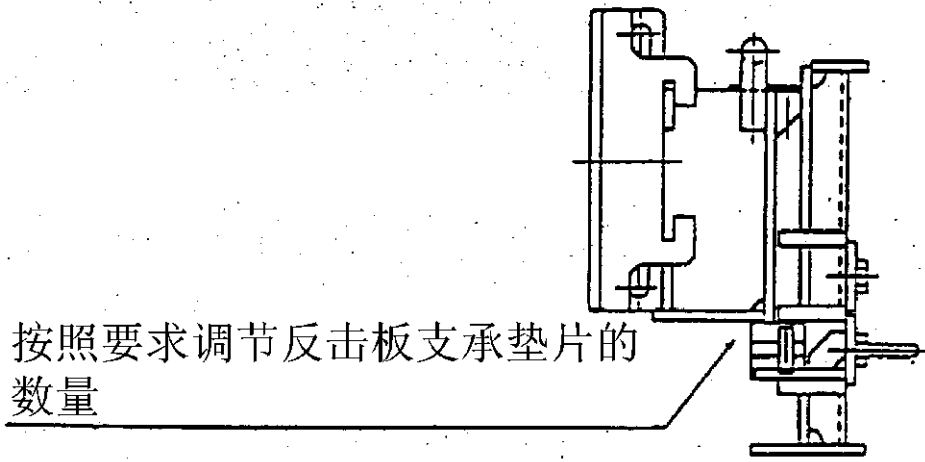

- 2.
- 3.

1

2

3

1.

2.

3

A

/

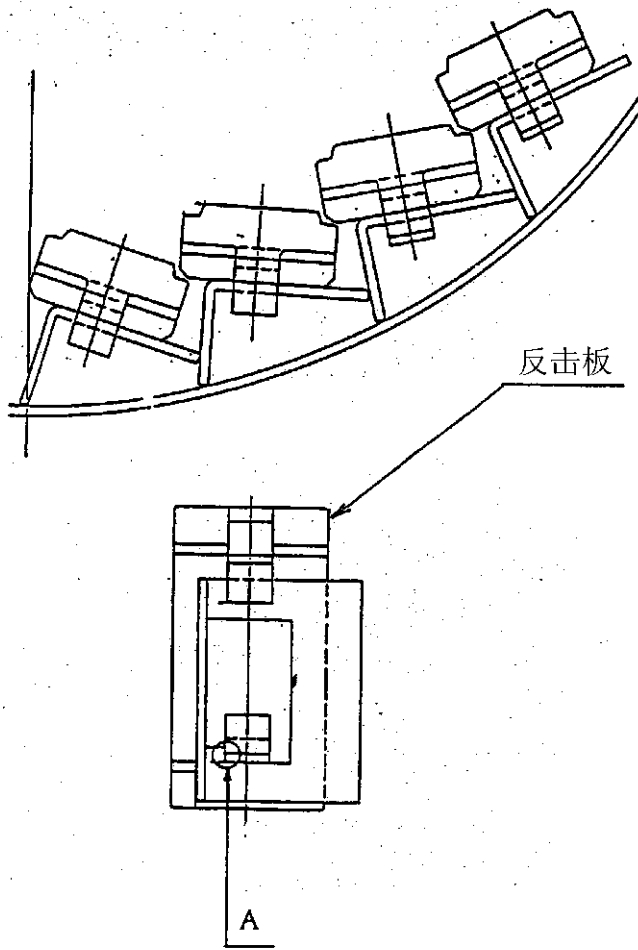

5.4

/

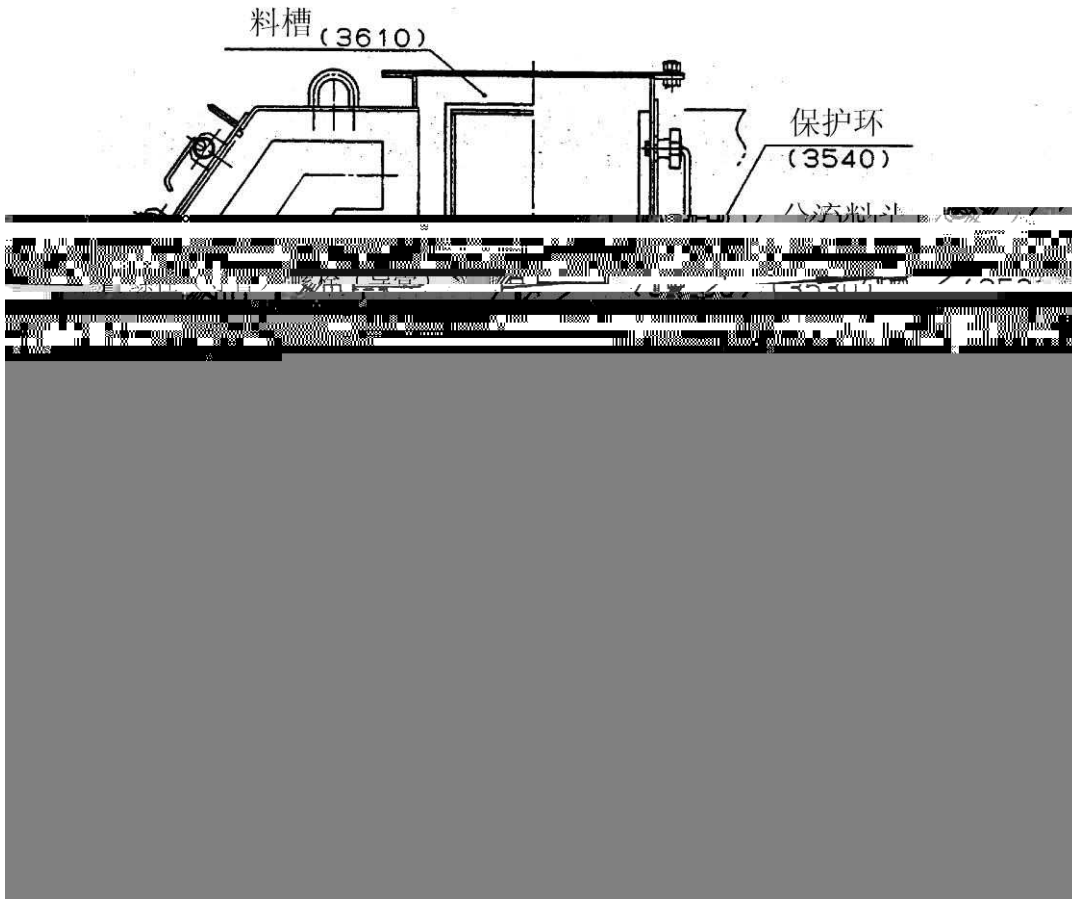

/

1

/

2

4

3

12

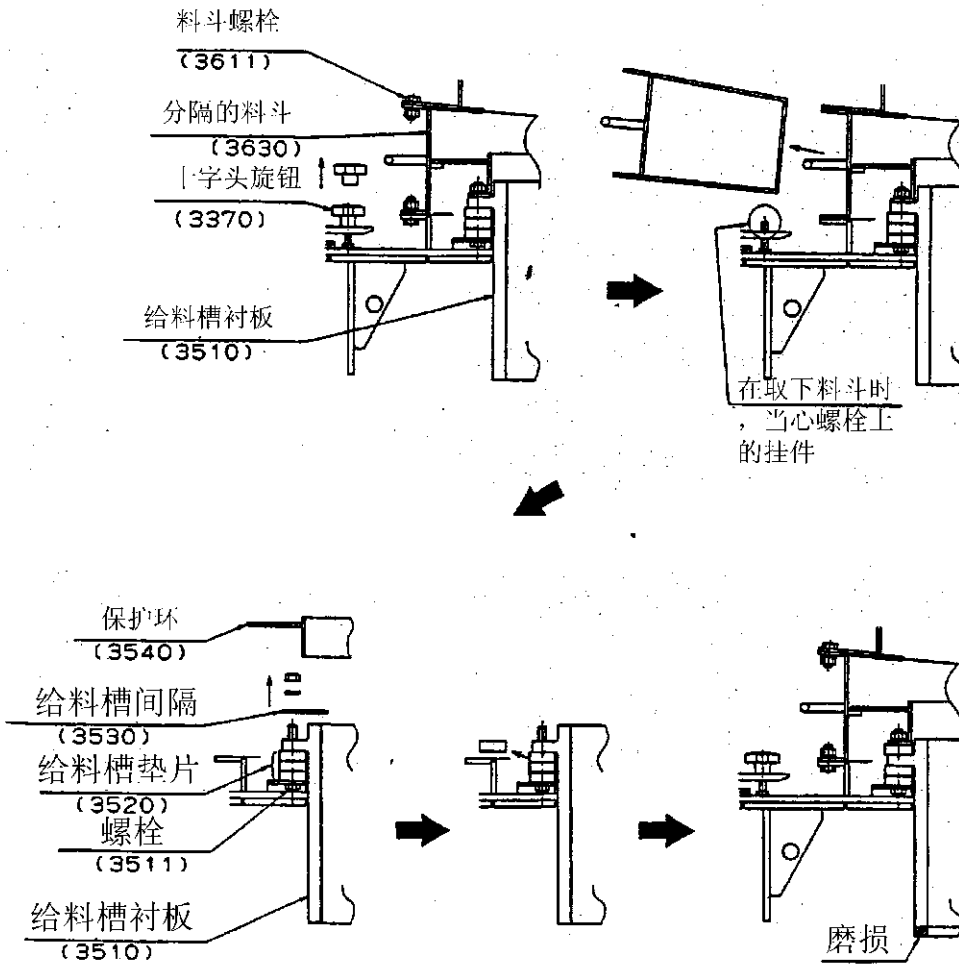

3

3

5.5

3

5.6

3

5.7

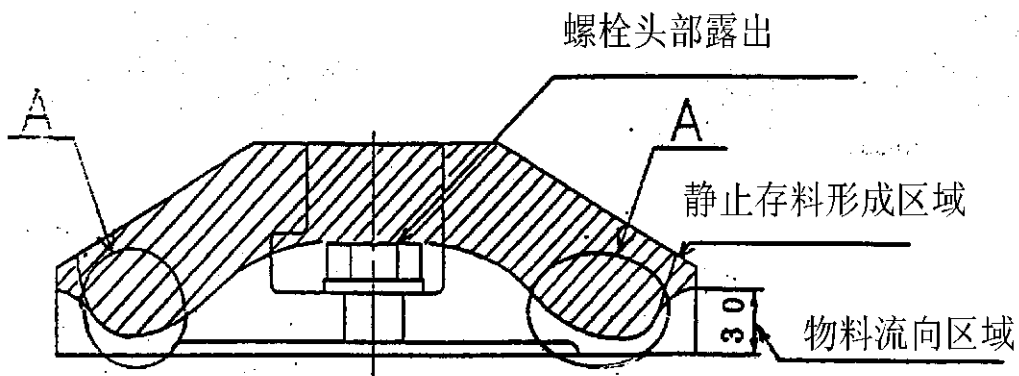

A

4

90

45

1

2

3

1

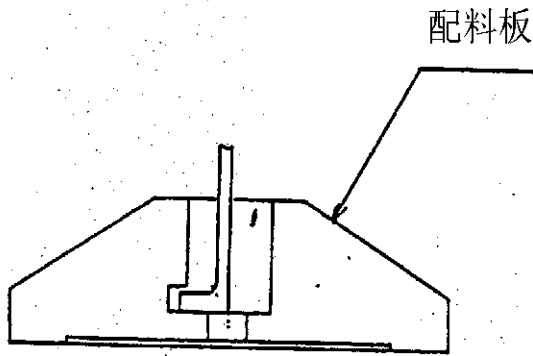

2

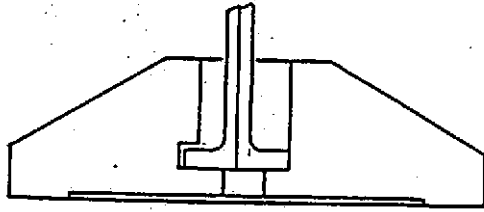

3

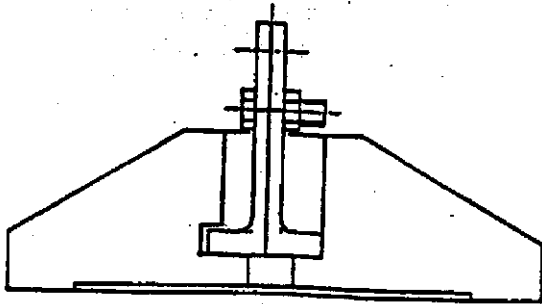

4

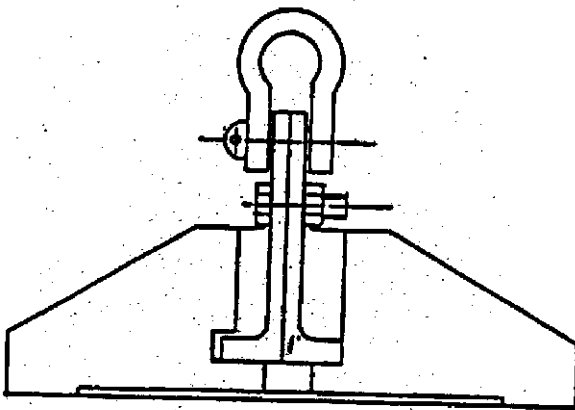

5.8

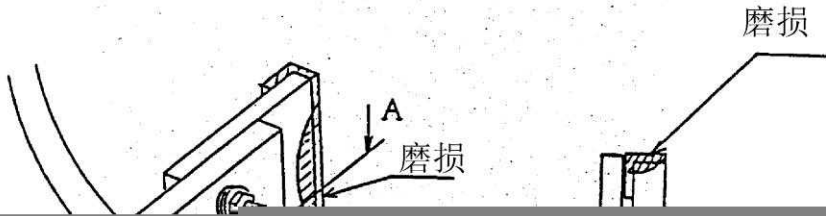

将其紧紧顶住上表面后，拧紧安装螺栓

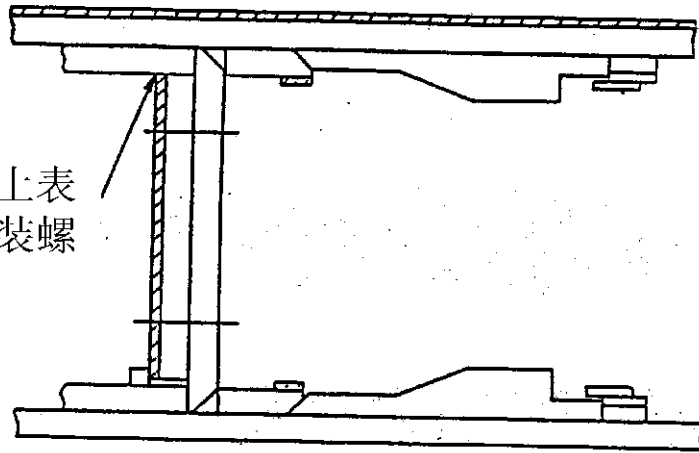

5.9

1

2

3

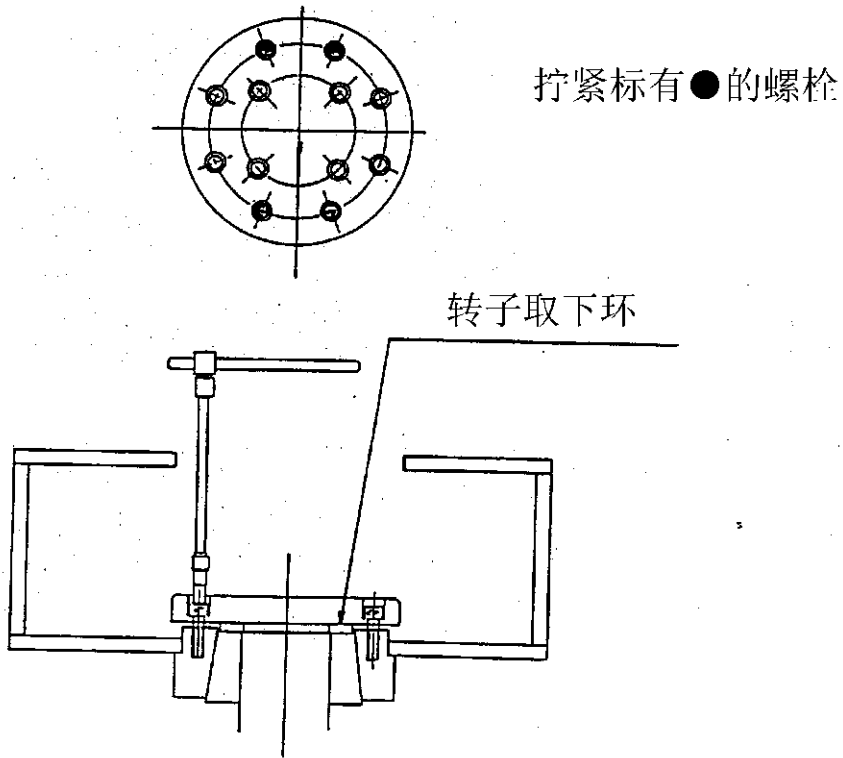

4

1

THREE BOND 1805

THREE BOND 1805

2

5.10 /

/

1

5

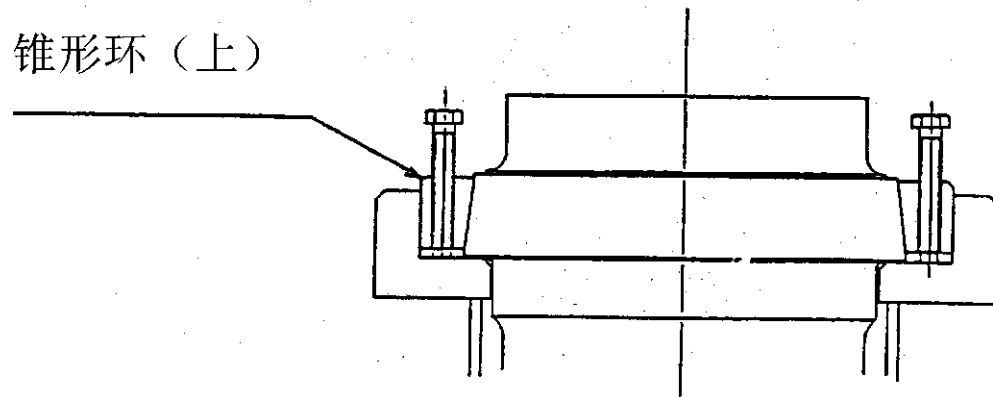

6

	1000	1200
	1.370kg	1.410kg

7

8

V

)B FKÖ@ iTwÑB ðÁ Y 3CQß p#{5>-84778<1C26>] A>-8<E9EA>-841D411B31C5

2

1

2

10

1

2

1

2

11

2

2

12

1

1

2

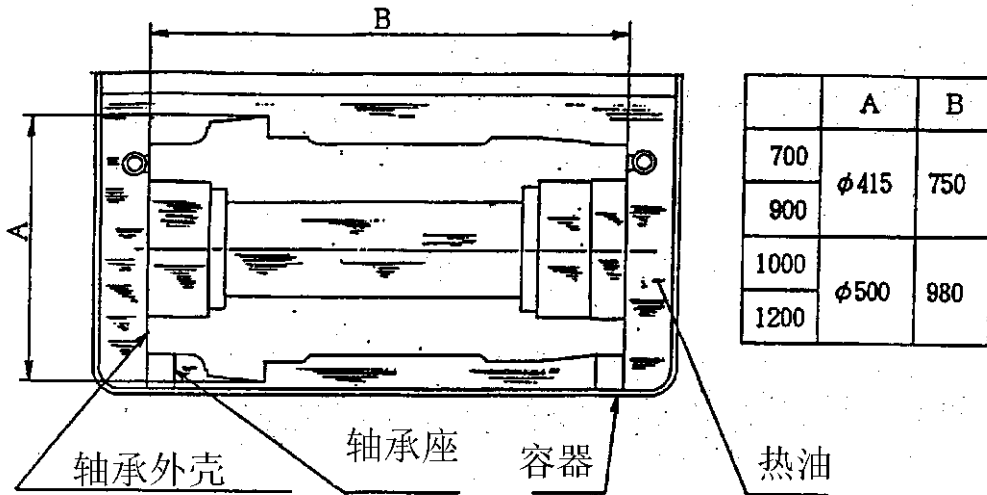

2

3

	1000	1200
1	350 g	440 g
2	360 g	450 g

4

245N

5.11

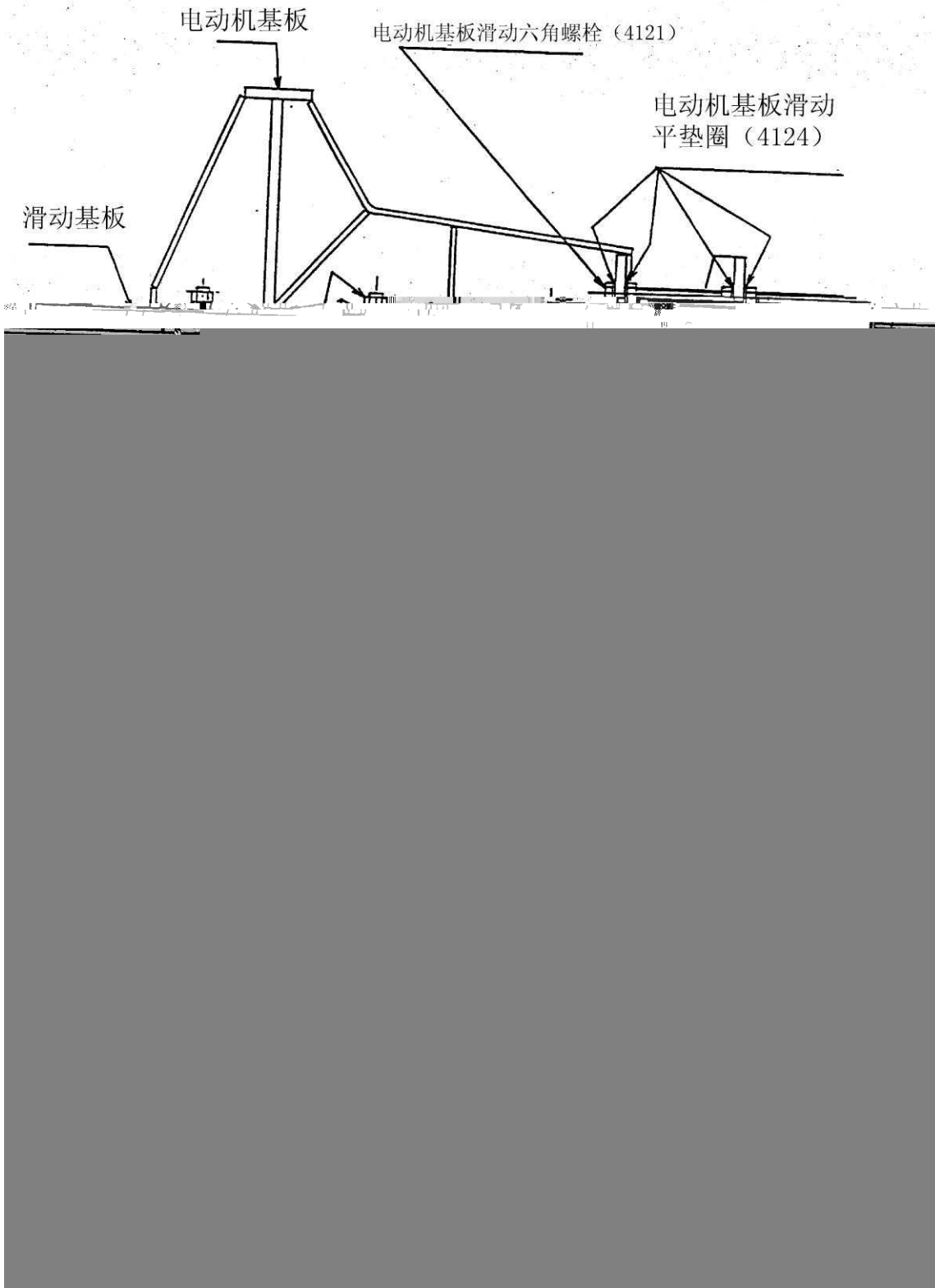

V

1

2

3

4 V

5

V

1

2

3

V

V

